

INDUSTRIAL DESIGN

Portfolio

INTERNET OF THINGS

WEARABLE & EMERGING TECH.

RESEARCH & DEVELOPMENT

ABOUT



“Understanding complex relationships among products, people & organizations.”

Ruchir Gupta a multi-disciplinary designer, with a focus on design research, industrial and product design, furniture design and installation art.

His work is an expression of his fascination with exploring new forms and media. He believes we are products of our past – so we understand backwards and live forward.

COLLABORATIONS & PARTNERSHIPS

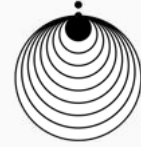

SKILLS



Rhinoceros
3D Digital Modelling



Keyshot
Product Visualization



Adobe Indesign
Graphic Package



Adobe Illustrator
Graphic Package



Notion
Management & Collaboration



Asana
Management & Collaboration



Microsoft Office
Workspaces



Wix Builder
Website



Figma
User Experience & Interface



Invision Studio
User Experience & Interface



Zeplin
Workflow Management & Dev.



Overleaf
Writing (LaTeX)

METHODOLOGY

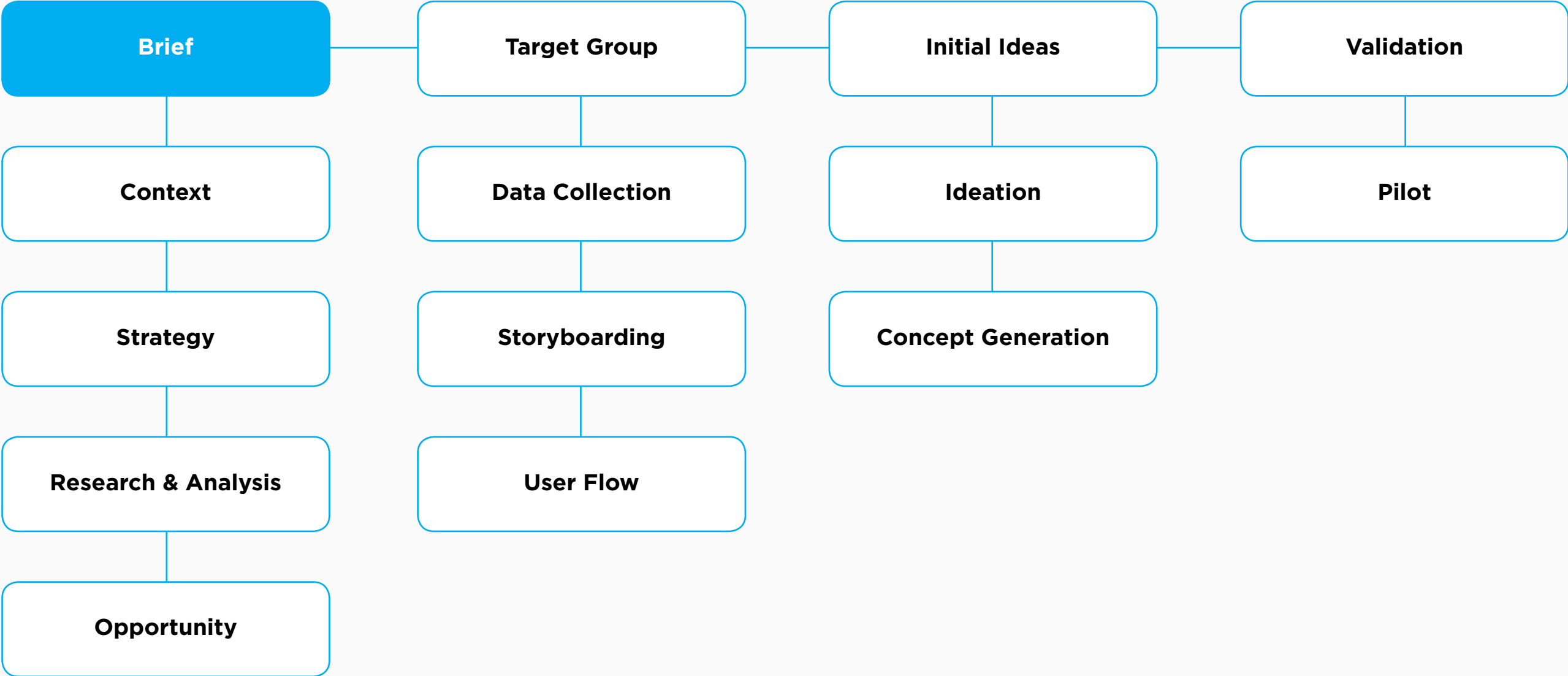

SKETCHING /
IDEATION

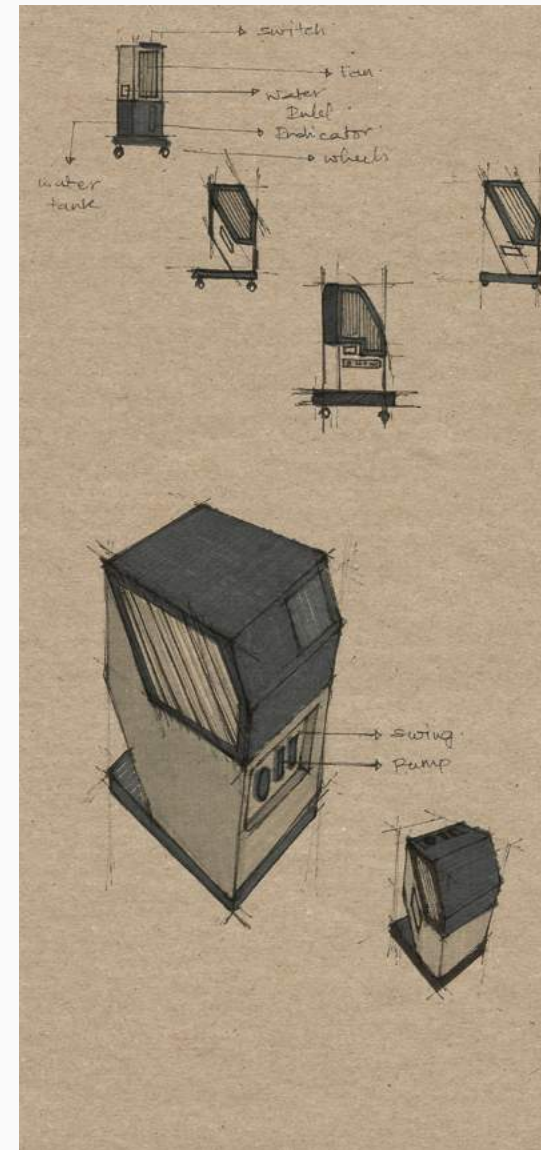
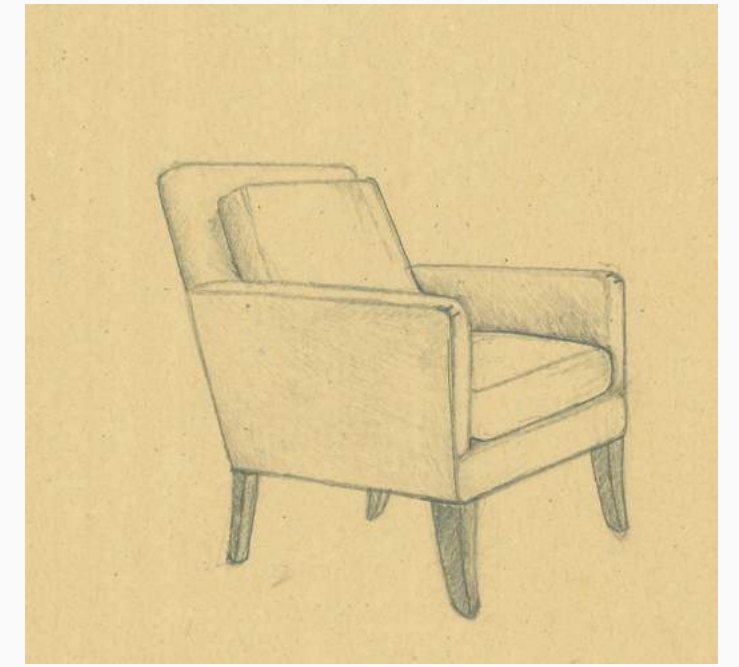
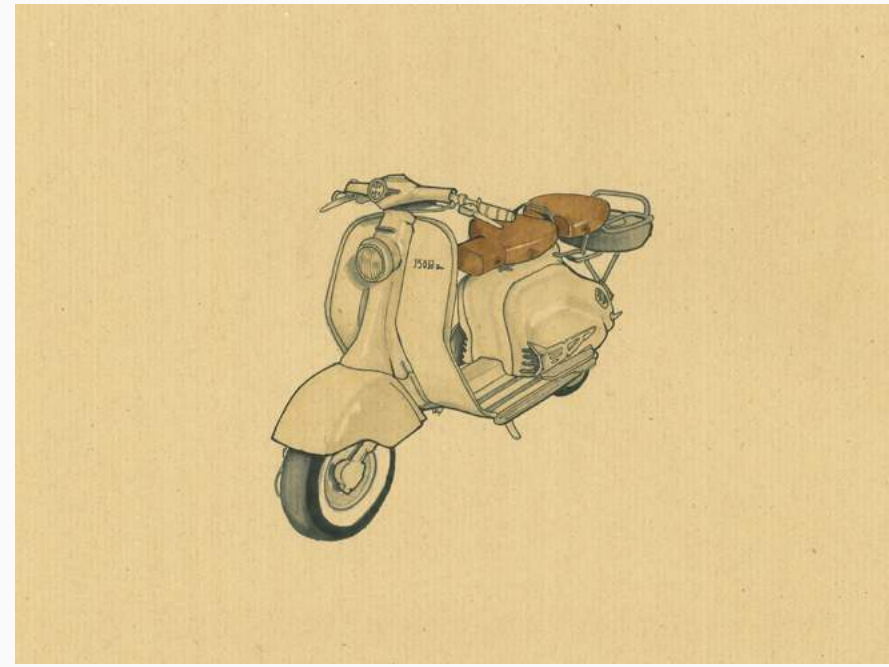

PROJECTS



www.mundaneeveryday.com

www.mundaneeveryday.com

01

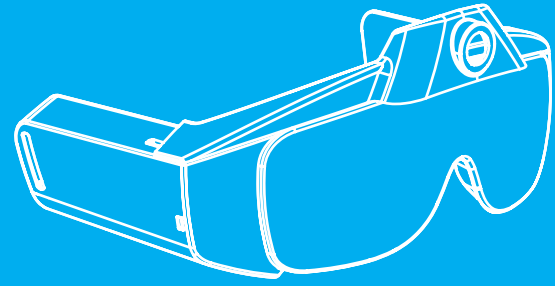

Smart PPE

02

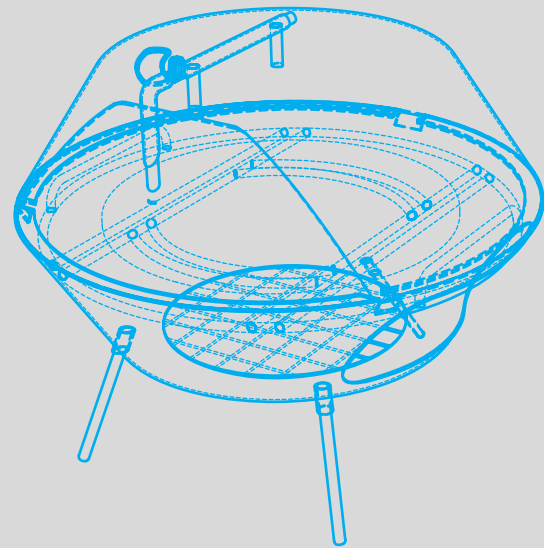

Camping Oven

03

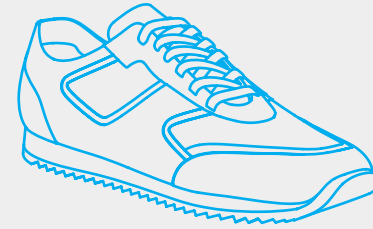

Haptic Footwear

04

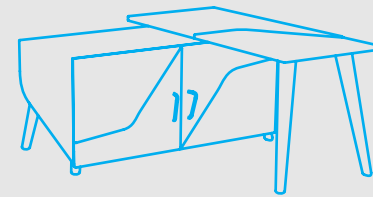

Mundane Everyday

05



Ceramic Kitchenware

06

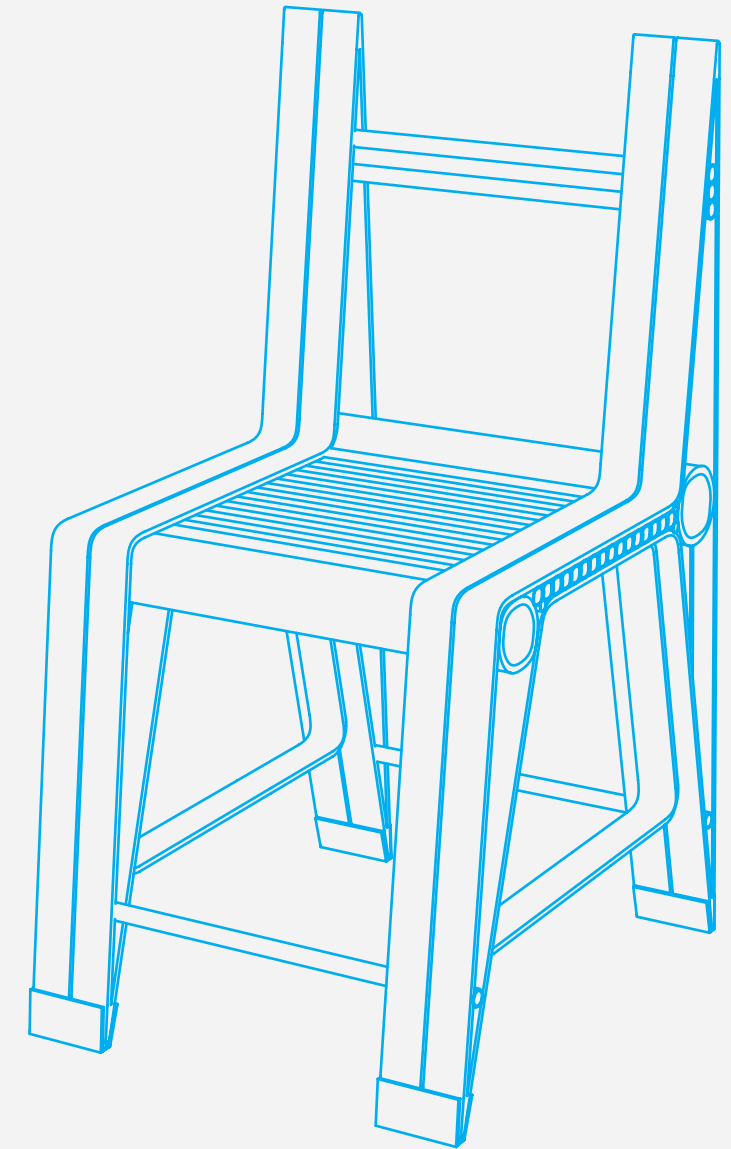

Bamboo Furniture

CollabLens™

COLLABLENS - SMART PPE

*Your On-site Assistant
in a Safety Glass*

CollabLens is an advanced daily-worn safety glass (not an AR/VR headset) that enables hands-free communication and information sharing through voice commands.

Role & Contribution

Design Lead
Menmitsu Private Limited

Responsible for the entire product cycle including ideation, proof of concept, MVP design, tangible user interface and experience along with the CMF and visual design for the company and the brand.

www.collablens.in



Form Explorations

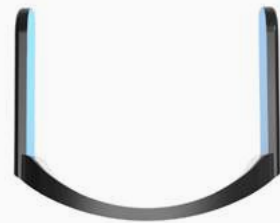

POC

R&D 1

R&D 2

R&D 3

MUP

MVP

angithi

ANGITHI -
CAMPING OVEN

Camping Oven

Stainless Steel top and bottom chamber, Copper door with Solid wood handles and Legs, 13" Pizza baking Stone.

Role & Contribution

Industrial Design Consultant
designEARTH Ovens

Developed customized design concepts and designed products, including Wood-fired Oven, Grills, Pizza Oven etc.

Created product catalogues and brochures; redesigned company's existing products to increase efficiency and improve quality, visited job sites to get measurements.

www.designearthovens.com



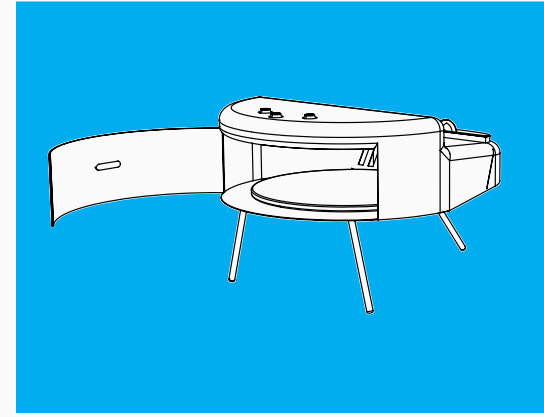
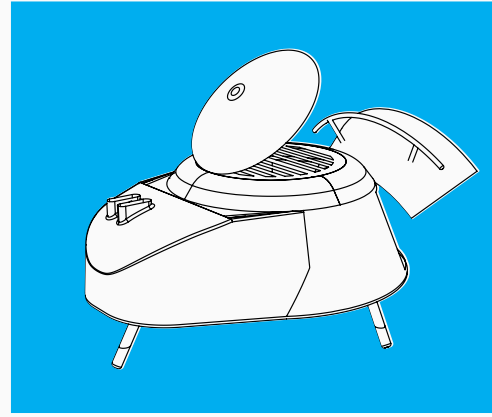
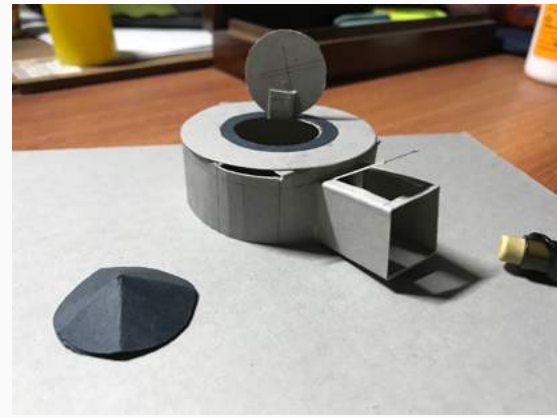
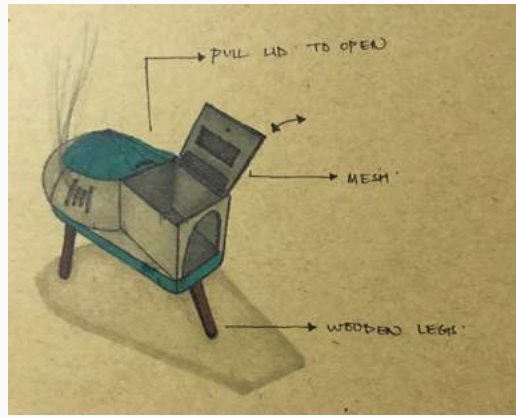

IDEATION



DESIGN DIRECTION

PROTOTYPE



TESTING



CAD



DETAILING



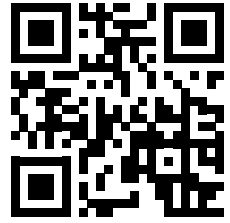

Website

LECHAL - HAPTIC FOOTWEAR

Handsfree Navigation

Intuitive, instinctive navigation through haptics or vibratory feedback. Like a tap on the shoulder, Lechal's gentle vibrations at your feet guide you invisibly but intuitively.

Role & Contribution

Product Designer
Ducere Technologies

At Ducere, the primary focus was on innovating intuitive, unobtrusive, and user-friendly connected wearable products. A few projects involved designing concepts related to haptic footwear, kids mobility, and tracking.

www.ducere.io



World's First Haptic Shoes

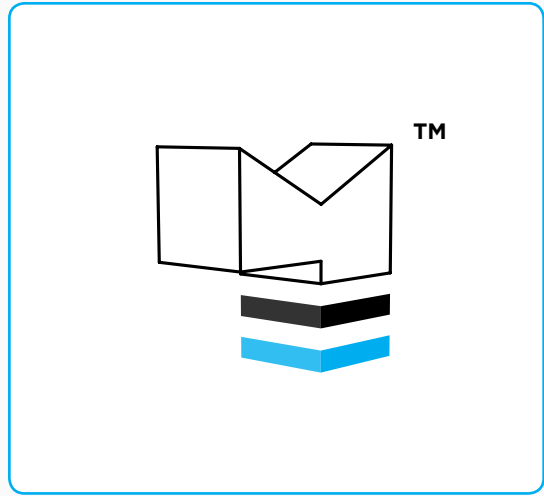

MUNDANE EVERYDAY

Mundane is about looking at everyday products through a different perspective in terms of product aesthetics, form, semantics, problem solutions and sometimes even the material choice.

The design outcomes may not always meet the desired market scenario but will always meet different arrays of markets through the designs.

Role & Contribution

Self Initiated Project

www.mundaneeveryday.com

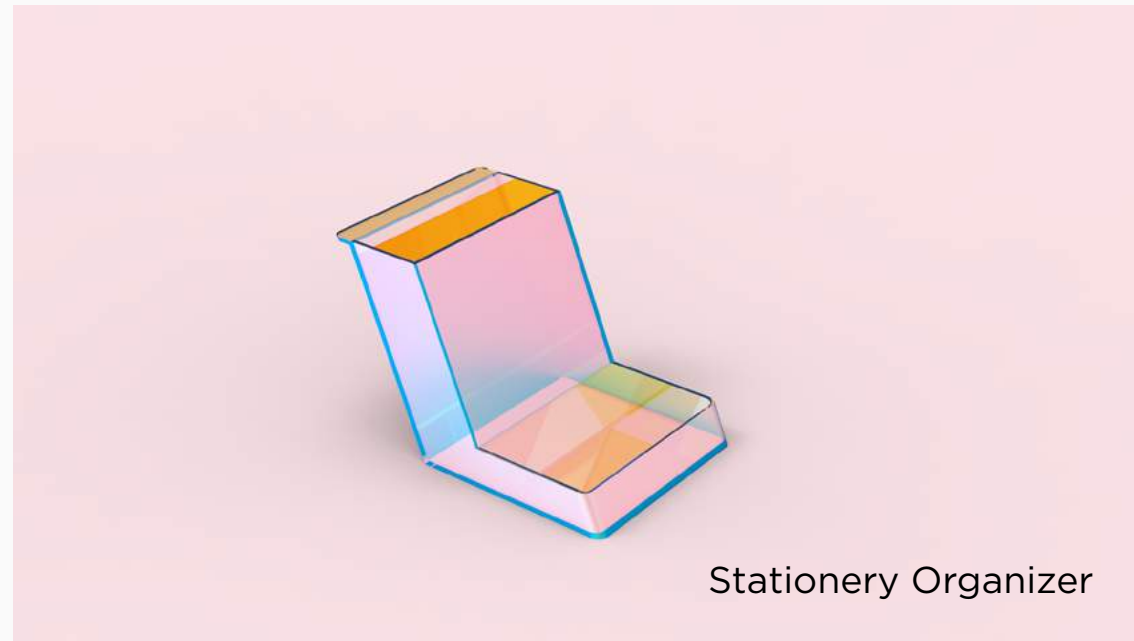

Stationery Organizer



Arm Chair

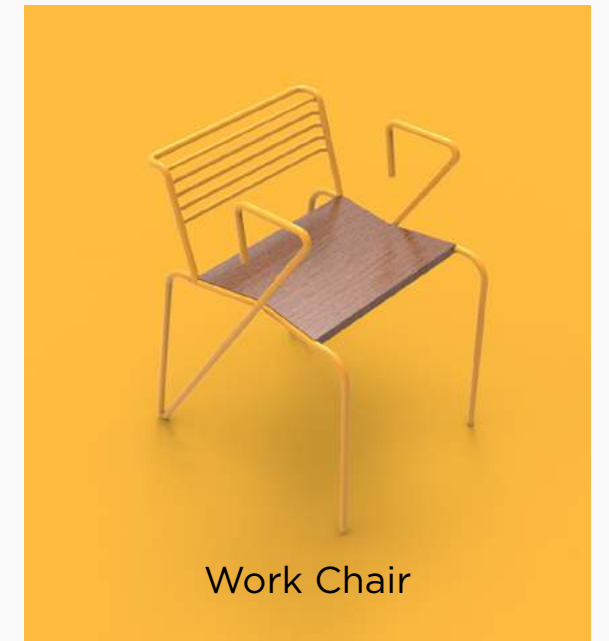

Work Chair



Bar Stool



Console Table



Cabinet



Fold Chair

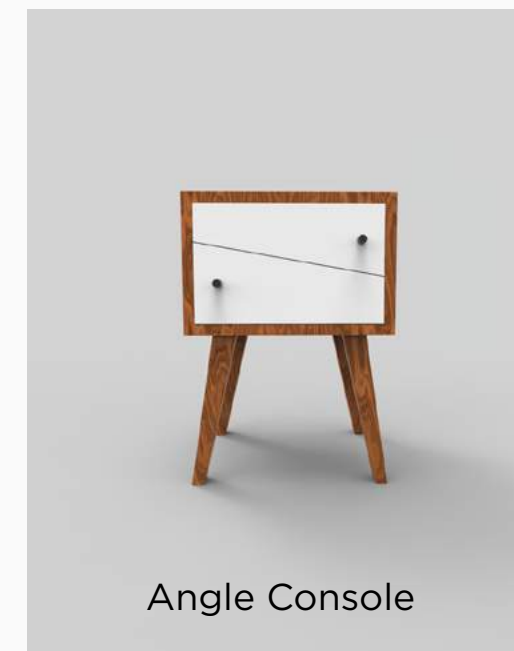

Angle Console



Task Lamp



Bend Table



Trash Can



Snake Lamp



Voronoi Lamp



Stool



Mini Console

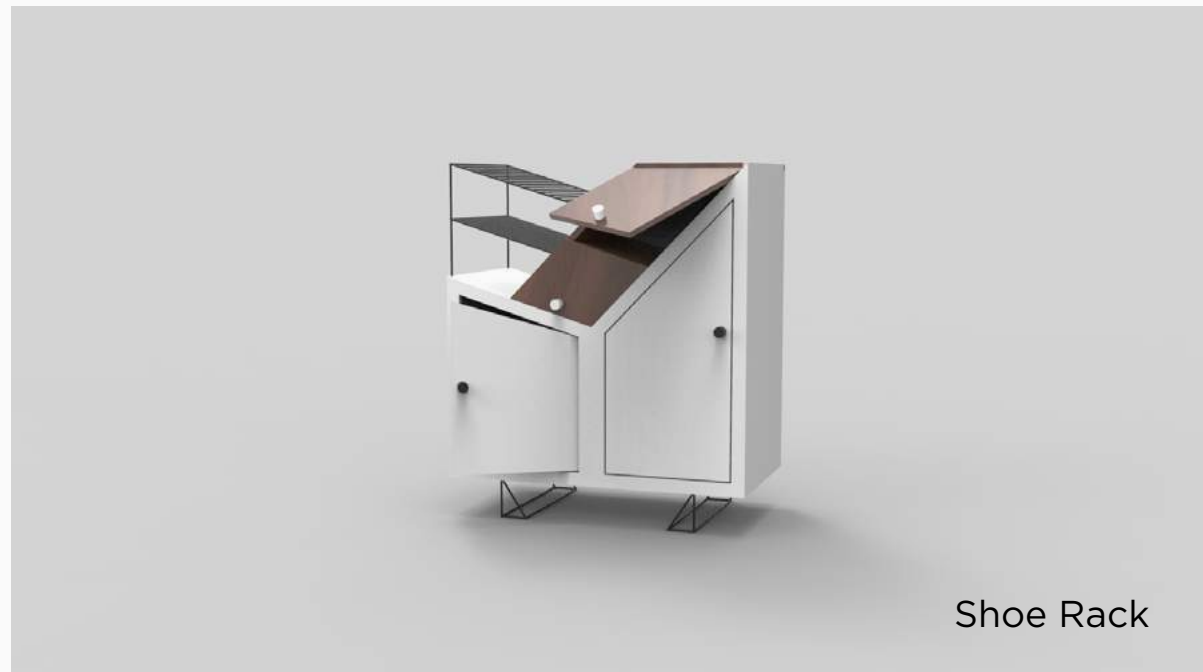

Shoe Rack



Workstation



Report

CERAMIC KITCHENWARE

The end outcomes emphasizes on the functional aspects of kitchenware which could be tableware such as - cutlery, or vessels used in the kitchen as day-to-day routine objects.

Ceramic Bowl, Mug, Glass and Plates with smooth glaze - easy to hold hot and cold items.

Made of durable porcelain, a type of premium LEAD-FREE and NON-TOXIC ceramic, chip-resistant and more sturdy than stoneware.

Role & Contribution
Thesis Project





Report

BAMBOO FURNITURE

Indigenous crafts with a Contemporary Vision

This project aims to create awareness about the indigenous crafts and traditional knowledge systems in India.

Further, it aims to engage with varied art and craft forms with a 'contemporary vision' and integrate them with design education and design industry in order to innovative directions in future.

Role & Contribution

Self Initiated Project



PRODUCT MOCK-UP

Rhinoceros
3D CAD Modelling

Keyshot
Product Visualization



INDUSTRIAL DESIGN

Thank You

INTERNET OF THINGS

WEARABLE & EMERGING TECH.

RESEARCH & DEVELOPMENT